

90W AC-DC POWER ADAPTER

MODEL: DESKTOP KT90W SERIES(C8)



WWW.HRCPOWER.COM

KEY FEATURES

- Universal AC Input 90~264VAC
- EMC Standard: EN55022 Class B and CISPR/FCC Class B
- Meet CEC & ErP Level VI
- Continuous Short Circuit Protection
- Overload Protection
- Over Voltage Protection
- Over Temperature Protection
- High Reliability
- Compact Design



SPECIFICATION

• OUTPUT

DC Voltage note.2	9.0-15V	15.1-48V
Rated Current	8.89A	5.96A
Current Range	0-8.89A	0-5.96A
Rated Power(max.)	80W	90W
Ripple&Noise(max.) note.3	350mV	350mV
Voltage Tolerance note.4	±5%	±5%
Line Regulation note.5	±1%	±1%
Load Regulation note.6	±5%	±5%
Start Delay, Rise, Hold up time	≤3000ms, 50ms, 10ms@230Vac / ≤3000ms, 50ms, 10ms@115Vac	

• INPUT

Voltage Range	90Vac ~ 264Vac	
Frequency Range	47 ~ 63Hz	
Efficiency(Typ.)	≥88%	≥88%
AC Current	1.5A/ 240VAC	
Inrush Current (max.)	cold start @25°C 120A/ 240VAC	
Leakage Current(max.)	≤0.75mA/ 240VAC	

• PROTECTION

Short Circuit Protection	support protection type : Hiccup mode, recovers automatically after fault condition is removed
Over Voltage Protection	105 ~ 135% rated output voltage protection type : Hiccup mode, recovers automatically after fault condition is removed

2 | DESKTOP KT90W SERIES

● PROTECTION

Overload Protection	110 ~ 150% rated output power, protection type : Hiccup mode, recovers automatically after fault condition is removed
Over current Protection	output power over 102%–250% of all rated DC output

● ENVIROMENT

Working Temperature	0 ~ +40°C
Working Humidity	5% ~ 90% RH non-condensing
Storage Temperature	-20 ~ +80°C
Storage Humidity	5% ~ 90% RH non-condensing
Vibration	working: 10-250Hz, 0.25G peak to peak, X, Y, Z axes,15min sweep storage: 10-300Hz,2.0G peak to peak, X, Y, Z axes,15min sweep
Altitude	5000m
MFBF	MIL-HDBK-217F(25), GB, at 25°C/115VAC, 50Khrs.

● SAFETY&EMC

Safety Standard	IEC/EN 60950,IEC/EN 60065;UL 62368; UL 60950; K-60950; J-60950; AS/NZS 60065,AS/NZS 60950;GB 4943
EMC Emission & EMC Immunity	EN 55032;EN 55035; EN 61000;AS/NZS CISPR 32;AS/NZS CISPR 32;KN 32; KN 35;GB9254;GB17625
Withstand Voltage	Primary(input AC)-to-Secondary(output DC), 1500 Vac, 10mA, 1 minute

● OTHERS

Dimension	140mm(L) x 65mm(W) x 26mm(H)
Weight&Packaging	350g/pc, 36pcs/carton

Note:

1. All parameters are specified at 230VAC input, rated load, 25°C 70%RH ambient.
2. The output voltage set at point measure by plug terminal&60% load.
3. Ripple noise are measured at 20MHZ by using a 12" twisted pair terminated with a 0.1uf&10uf capacitor.
4. Tolerance: includes set up tolerance, line regulation, load regulation.
5. Line regulation is measured from low line to high line at rated load(100V to240V).
6. Load regulation is measured from 60% to 100% rated load and 60% to 20% rated load.

SPECIAL INSTRUCTION

Please keep reading the following safety notes before use or examination.

1. Primary technical specification of the marking on the product.
2. The product is used only within doors or at the dry location.
3. Don't store or use this product in the erodent condition.
4. The ambient temperature around the prod uct must be kept for room temperature because overcool can effect on the feature and working life of product.
5. The power supply applies only to the highest temperature 40 °C, and without any covering
6. According to the technical specification of product, it must be connected with correct power input and specified out put load or terminal appliance so that it can't be broken. Pay attention to the input voltage & frequency.
7. The disconnection from line voltage is taken by pulling the mains plug.
8. The product is not intended to be repaired by service personnel in in case of failure including component defect of crack of the enclosure and external flexible cord damaged etc, it must be discarded.
9. Fuses replaceable only by service personnel.

Output Polarity:



MECHANICAL SPECIFICATION

Unit:mm

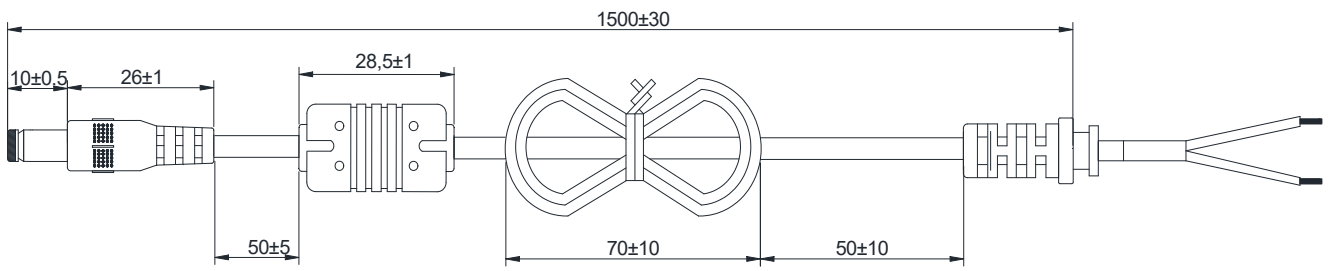

- UL1185, AWG #16/18/22*2C L=1500±30mm.
- Plug, 5.5*2.1*10mm, straight tuning fork style.
- Color, black.
- With annular core.
- PAHS REACH RoHS.

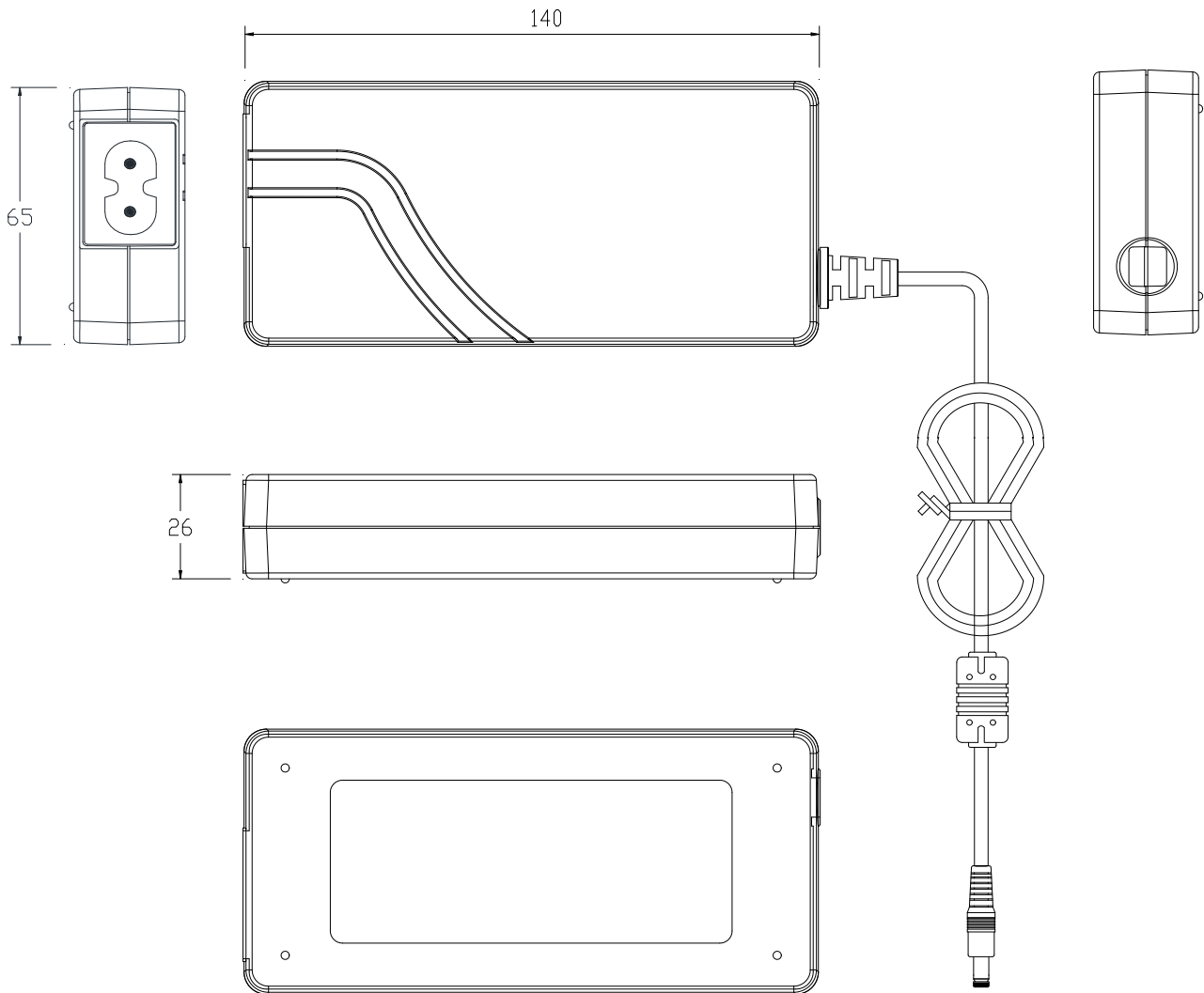

- More options of DC cable&plug and AC cable&plug are available by customer requested